

É NESSE MOMENTO QUE A TRANSFORMAÇÃO ACONTECE.

OLÁ MARCENA!
SEU MÓVEL CHEGOU.
HORA DA DIVERSÃO =]

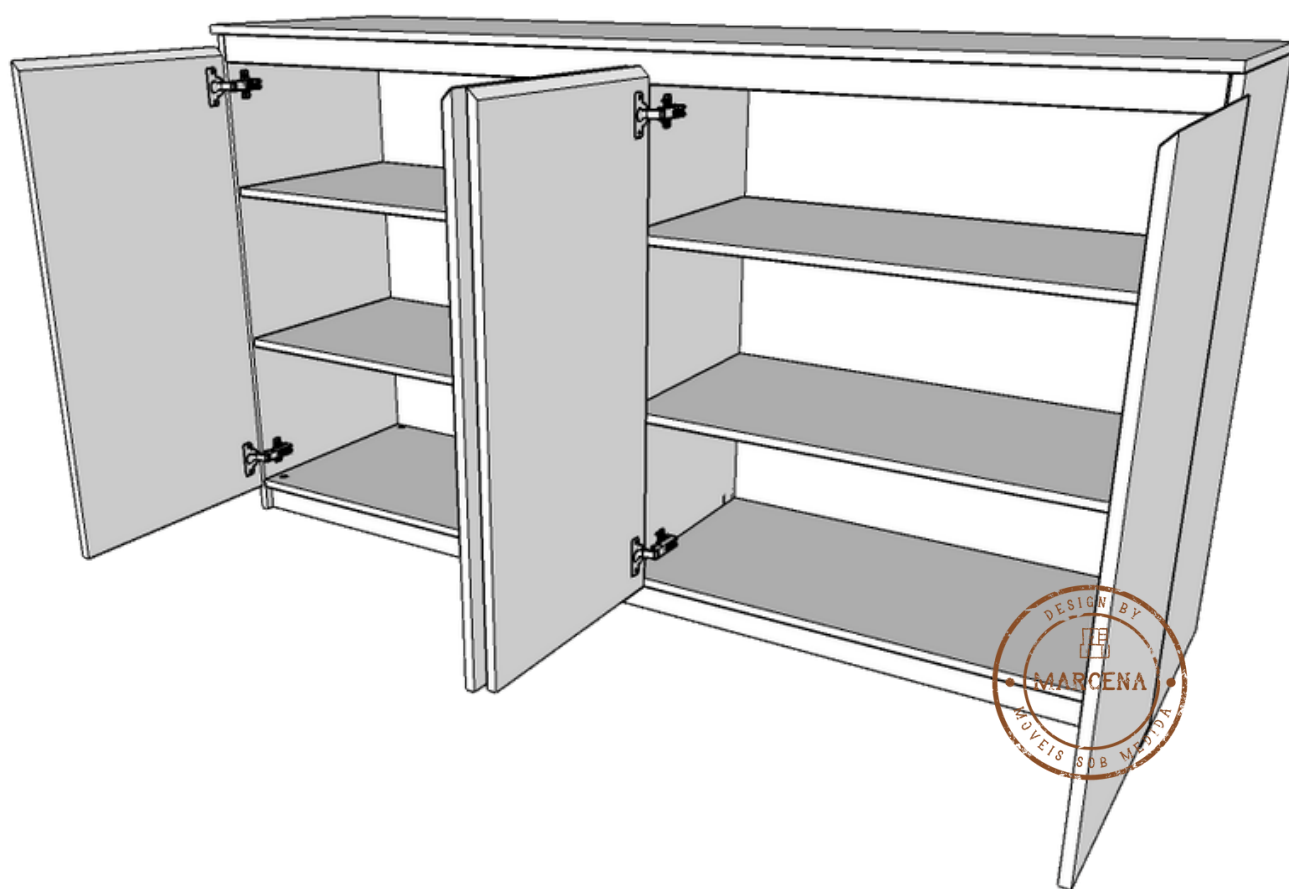

MANUAL DE MONTAGEM
BANCADA BUFFET 4 PORTAS

CÓDIGO: BFBF03

marcena
móveis sob medida

marcena.com.br

POR ONDE COMEÇAR

- 1.** AO RECEBER SEU PRODUTO VERIFIQUE SE A EMBALAGEM ESTÁ LACRADA E SE O MÓVEL NÃO TEM NENHUMA AVARIA.
- 2.** ARRUME O LOCAL ONDE O MÓVEL IRA FICAR E LIBERE UM ESPAÇO PARA PODER TRABALHAR NA MONTAGEM DO SEU MÓVEL. O ESPAÇO PRECISA SER COMPÁTIVEL COM O TAMANHO DO SEU MÓVEL. DICA: QUANTO MAIS ESPAÇO LIVRE TIVER A MONTAGEM SERÁ MAIS FÁCIL.
- 3.** SEPARE AS PEÇAS E CONFIRME QUE NÃO FALTA NADA. SEPARE E ORGANIZE AS PEÇAS CONFORME IMAGEM 01.
- 4.** SIGA OS PASSOS NA ORDEM E TENHA ELE MONTADO EM POUCO TEMPO. DEPOIS É SÓ LIMPAR O ESPAÇO E APROVEITAR SEU NOVO MÓVEL!

MANUTENÇÃO E LIMPEZA

A LIMPEZA DO MÓVEL EXIGE APENAS A RETIRADA DO PÓ COM UM PANO SECO. PODE SER FEITO UTILIZANDO O PANO LEVEMENTE UMEDECIDO COM ÁGUA E UM POUCO DE DETERGENTE NEUTRO. EM SEGUIDA SEQUE A SUPERFÍCIE COM A AJUDA DE UM PANO LIMPO E MACIO.

NÃO APLIQUE PRODUTOS COMO SILICONES, CERAS E LUSTRA-MÓVEIS. ELES PODEM DEIXAR AS SUPERFÍCIES DO MDF COM ASPECTO “ENGORDURADO”.

NÃO UTILIZE DESENGORDURANTES E PRODUTOS MULTIUSOS. ELES PODEM OCASIONAR MANCHAS AMARELADAS NA SUPERFÍCIE DOS PAINÉIS E DAS FITAS DE BORDA.

NÃO UTILIZE ESPONJAS E BUCHAS QUE POSSAM RISCAR O REVESTIMENTO OU DANIFICAR AS BORDAS DOS PAINÉIS.

INFORMAÇÕES DO PRODUTO

 60MIN TEMPO DE MONTAGEM
 1/2 PESSOAS PARA MONTAGEM

FERRAMENTA NECESSÁRIA:
CHAVE PHILLIPS

LISTA DE FERRAGENS INCLUSAS

14X



TAMBOR
GIROFIX

14X



PINO
GIROFIX

14X



CAVILHA

14X



ACABAMENTO
GIROFIX
MARROM

4X

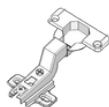

DOBRADIÇAS
RETAS

4X

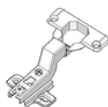

DOBRADIÇAS
CRUVA

2X



CANTONEIRA
EM L PRETO

16X



PINO DE
PRATELEIRA

36X



PARAFUSO
4X16

0X



PÉ
REGULÁVEL

LISTA DE PEÇAS DO MÓVEL

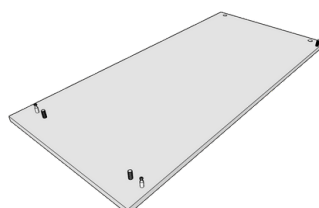

2X - LATERAIS

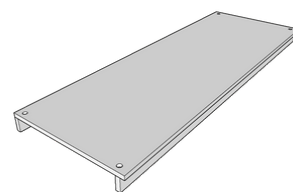

1X - BASE

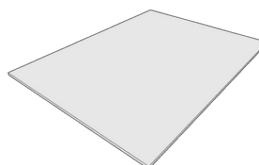

1X - FUNDO

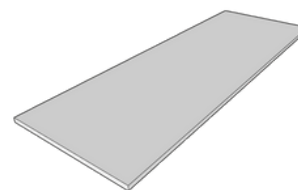

4X - PRATELEIRA

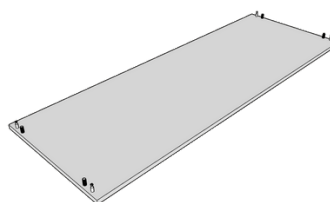

1X - TAMPO

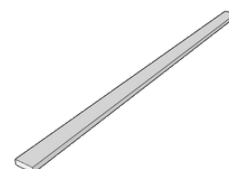

1X - TRAVESSA

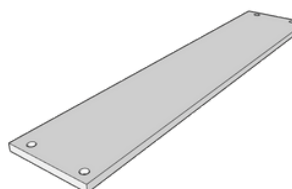

1X - DIVISÓRIA

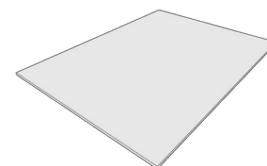

4X - PORTAS

PASSO 1.

SEPARE TODAS AS PEÇAS E FERRAGENS DE FORMA A IDENTIFICAR CADA PARTE.

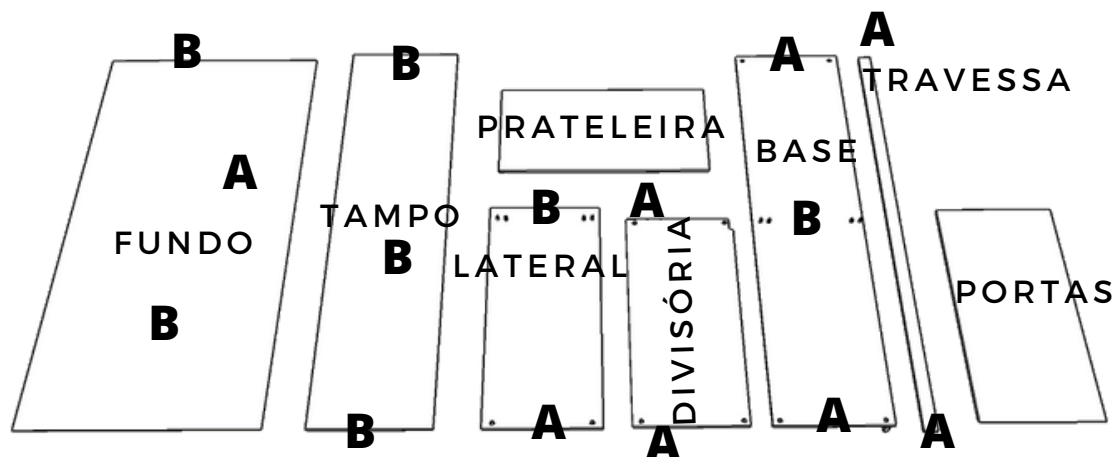
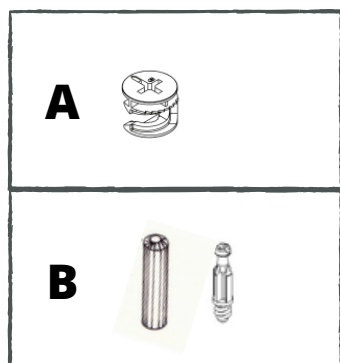

PASSO 2.

INSTALE OS PINOS GIROFIX E CAVILHAS NAS LATERAIS, TAMPO E BASE.

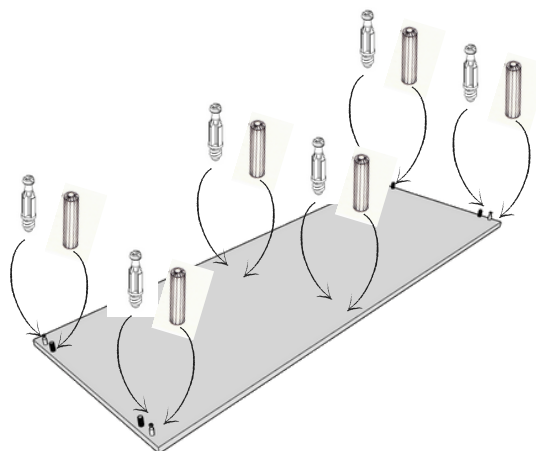
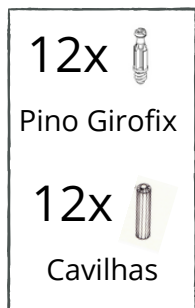

1X - TAMPO

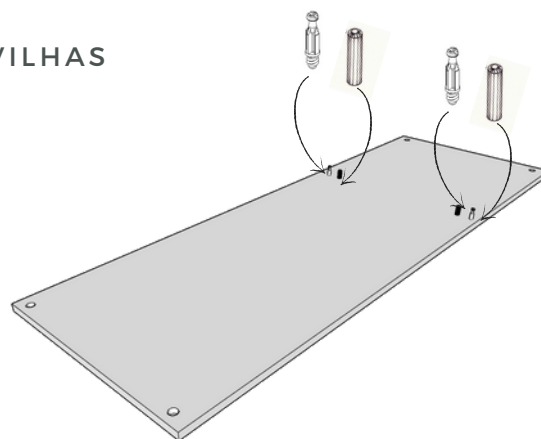

1X - BASE

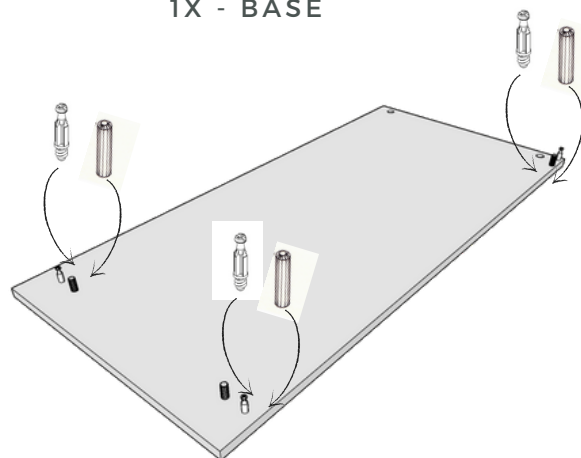

2X - LATERAL

ANTES DE COMEÇAR

SIGA ESSA ORIENTAÇÃO PARA TRABALHAR COM AS CAVILHAS, PINOS E TAMBOR GIROFIX.

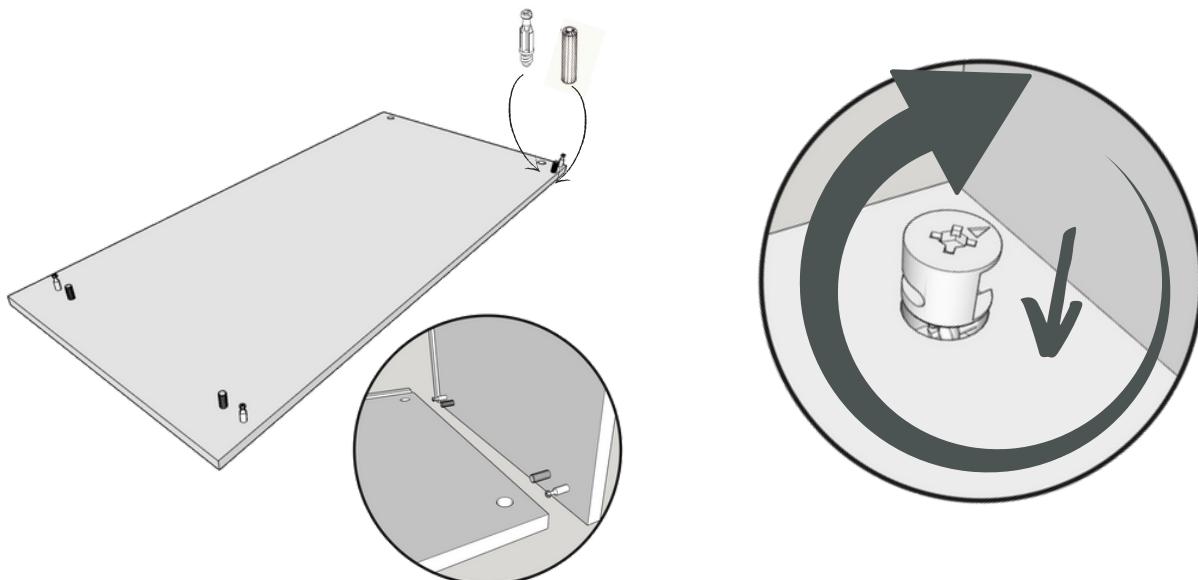

ENCAIXE AS CAVILHAS E OS PINOS GIROFIX QUE DEVEM FICAR NA FURAÇÃO REDONDA

DEPOIS DE ENCAIXADA AS PARTES, COLOQUE O TAMBOR GIROFIX E GIRE COM A CHAVE PHILLIPS PARA DAR APERTO.

REPARE QUE O TAMBOR GIROFIX TEM UMA SETA QUE INDICA A POSIÇÃO INICIAL PARA SER ENCAIXADO NA PEÇA DO MÓVEL.

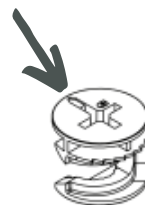

PASSO 1.

ENCAIXE A LATERAL E DIVISÓRIA NOS PINOS DA BASE E APERTE O GIROFIX

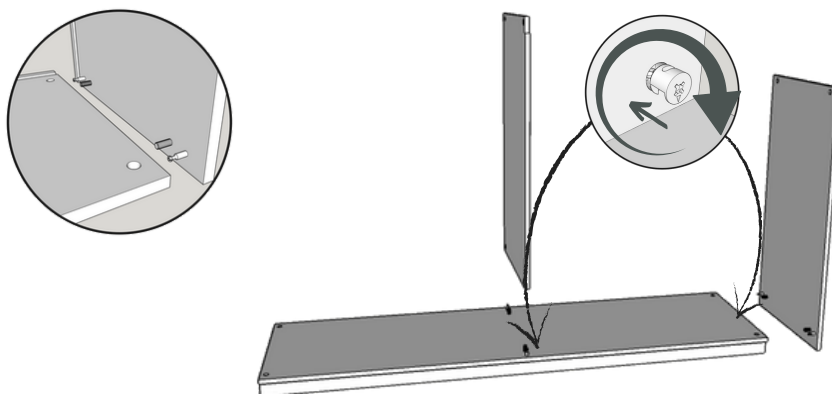

PASSO 2.

ENCAIXE O FUNDO NO CANAL DA LATERAL E DA BASE

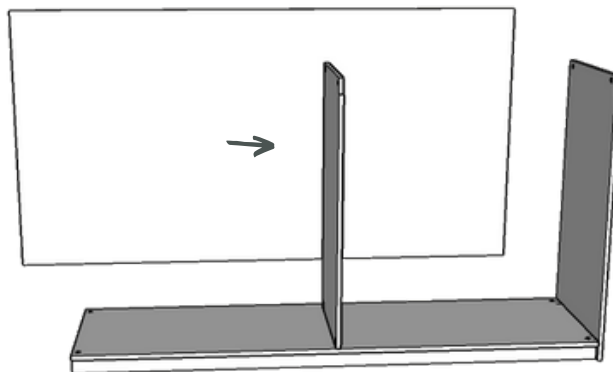

PASSO 3.

ENCAIXE A TRAVESSA NA POSIÇÃO E APERTE O TAMBOR DE GIROFIX NA LATERAL, NA DIVISÓRIA COLOQUE AS CADEIRINHAS E FAÇA A FIXAÇÃO COM OS PARAFUSOS 4X16

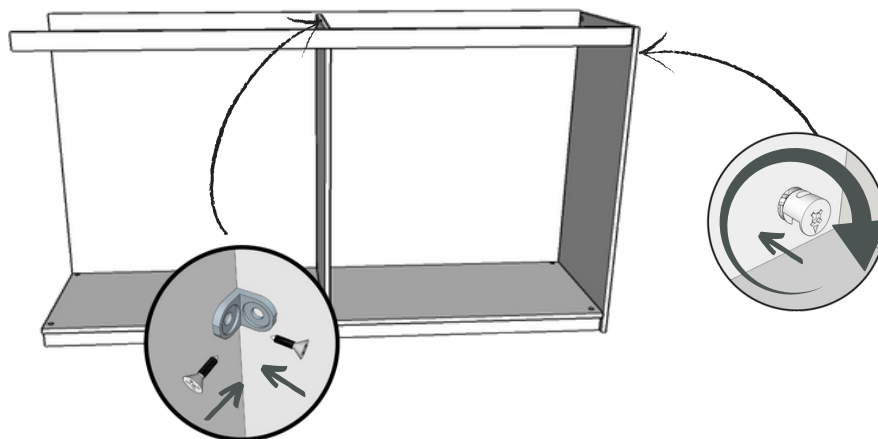

PASSO 4.

ENCAIXE A OUTRA LATERAL NA BASE A PAINEL E EM SEGUIDA COLOQUE OS TAMBORES DE GIROFIX E DE O APERTO.

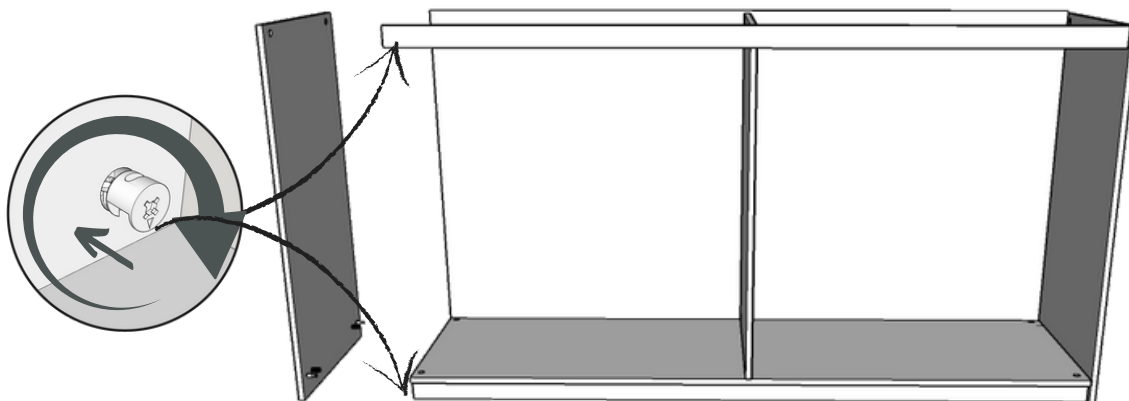

PASSO 5.

ENCAIXE O TAMPO NAS LATERAIS, EM SEGUIDA COLOQUE OS TAMBORES DE GIROFIX E DE O APERTO COM A CHAVE PHILLIPS.

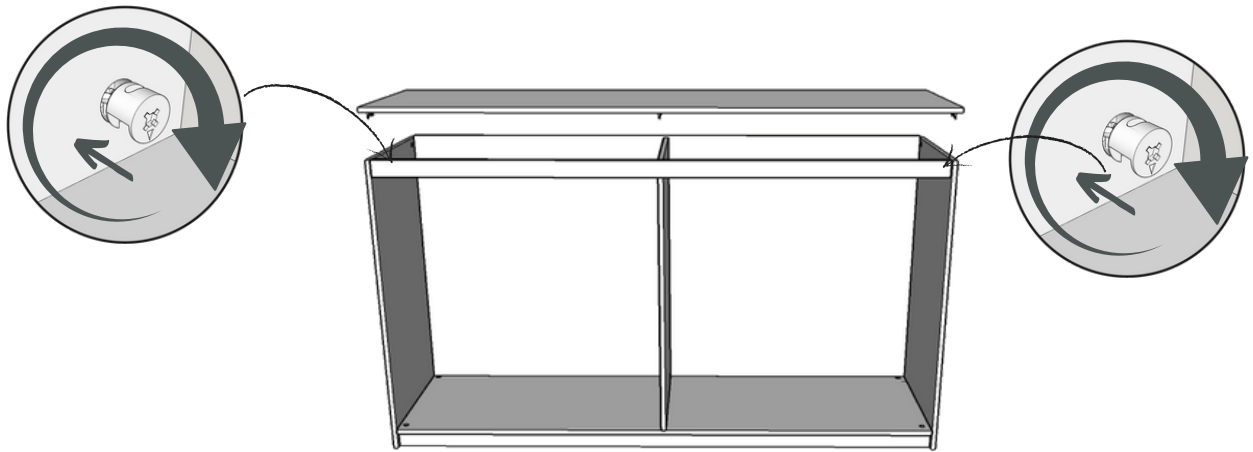

PASSO 6.

COLOQUE OS PINOS DAS PRATELEIRAS NAS LATERAIS E ENCAIXE AS PRATELEIRAS NO LOCAL.

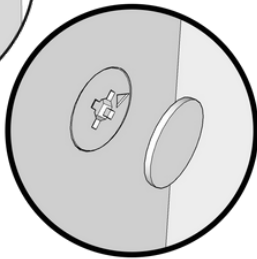
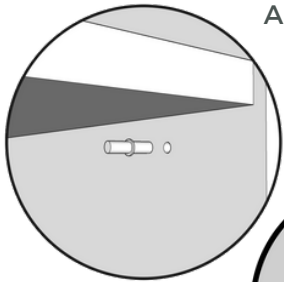

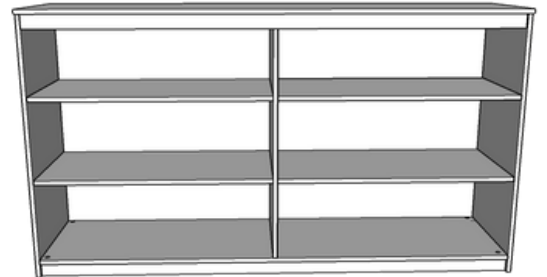

12x 
Acabamento
Girofix

COLOQUE TODOS OS ACABAMENTOS DOS TAMBORES DE GIROFIX.



PASSO 7.

INSTALE AS DOBRADIÇAS NAS PORTAS.

4x 
Dobradiças Curva
4x 
Dobradiças Retas
16x 
Parafuso 4x16

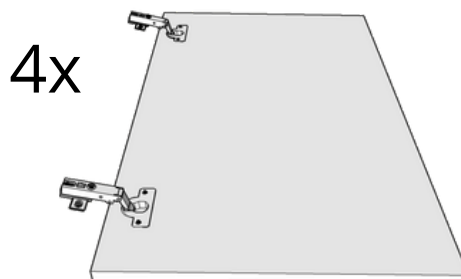

REPARE QUE AS DOBRADIÇAS CURVAS TEM UM ADESIVO REDONDO VERMELHO, E NAS PORTAS E LATERAL QUE DEVE SER INSTALADA TAMBEM TEM ADESIVOS VERMELHOS.

PASSO 8.

INSTALE AS PORTAS NA CAIXA MONTADA.

*** ATENÇÃO AS DOBRADIÇAS CURVAS DEVEM SER INSTALADAS NA PORTA DO MEIO PARA CONSEGUIR A REGULAGEM ADEQUADA, ELAS SÃO SINALIZADAS COM ADESIVO VERMELHO***

16x



Parafuso 4x16

SE NECESSÁRIO FAÇA A REGULAGEM DA PORTA E ENCAIXE OS ACABAMENTOS DAS DOBRADIÇA

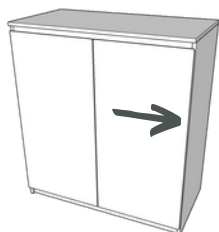
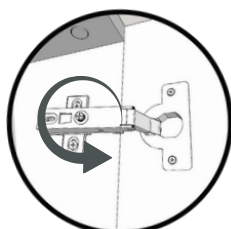
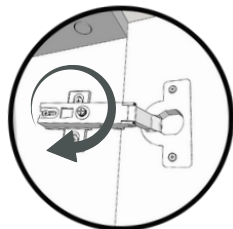

PORTA PARA FORA

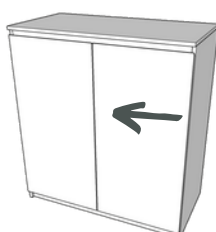

PORTA PARA DENTRO

DOBRADIÇAS CURVAS

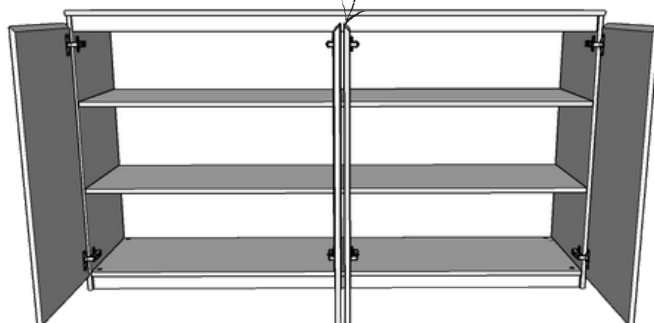

PASSO 9.

COLOQUE NA POSIÇÃO E APROVEITE SUA BANCADA BUFFET!

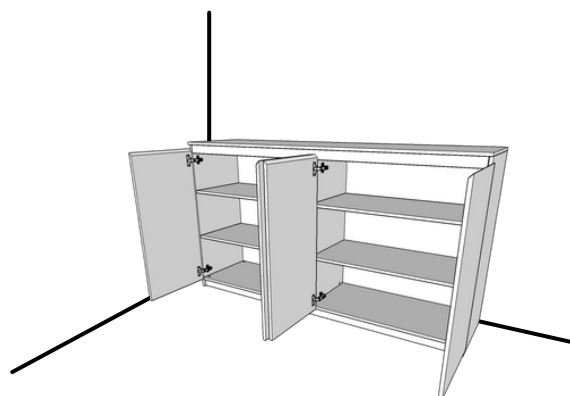

Siga-nos
nas
**REDES
SOCIAIS**



@MARCENAMOVEIS



@MARCENADESIGN



@MARCENADESIGN

COLOQUE FOTO DA SUA MONTAGEM OU DO MÓVEL PRONTO E NOS MARQUE NAS REDES SOCIAIS. =]